

S100 ...B/T

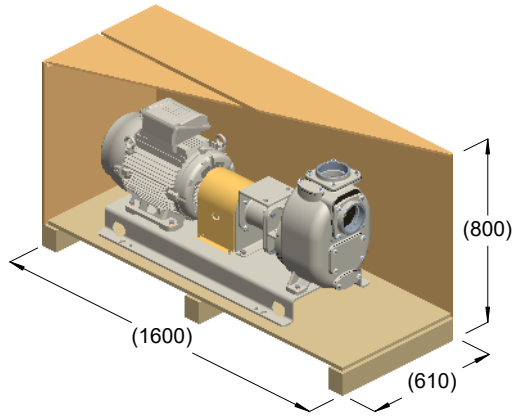

kg = 262
m³ = 0.78

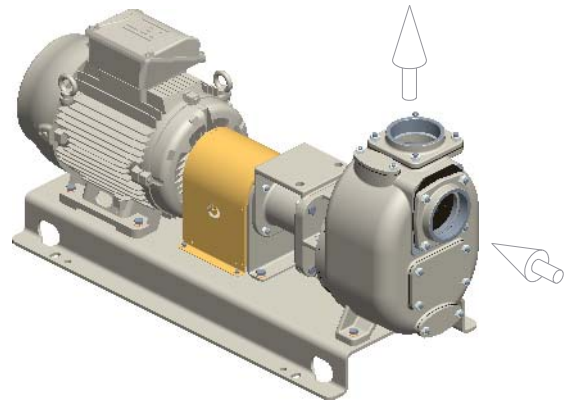

kg = 240

